



1400 2400

ELECTRIC GRILL OWNER'S GUIDE

You must read this Owner's Guide before operating your electric grill.

PLACE STICKER HERE



WARNING!
POTENTIAL SHOCK HAZARD

This appliance is rated for
220V-240V - 50/60Hz
Output: 2200 W



- ⚠ Read all instructions prior to operating.
- ⚠ The appliance is to be connected to a socket having an earthing contact.
- ⚠ The appliance should be supplied through a residual current device (RCD) having a rated residual operating current not exceeding 30 mA.
- ⚠ Do not operate unit if plug receptacle is damaged.
- ⚠ The power cord should be regularly examined for signs of damage and the appliance is not to be used if the cord is damaged.
- ⚠ Do not operate barbecue with a temperature controller that has a damaged cord or plug. Call WEBER for a replacement temperature controller. The temperature controller is made specifically for this barbecue.
- ⚠ Always plug temperature controller into barbecue before plugging power cord into socket.
- ⚠ When removing the temperature controller from the barbecue, unplug it first.
- ⚠ During long periods of non-use, remove temperature controller from barbecue. Always store temperature controller indoors when not in use.
- ⚠ Do not immerse temperature controller with power cord for cleaning.
- ⚠ Do not immerse barbecue in water when cleaning.
- ⚠ To protect against electrical shock, do not immerse plug, cord or heating element controller in water or any other liquid.
- ⚠ Keep plug and cord dry when in use.
- ⚠ Do not use barbecue when raining.
- ⚠ Operate barbecue only on a level, stable surface.
- ⚠ Do not use charcoal or other combustible fuels in this barbecue. This barbecue is not designed for charcoal use and a fire could result. The fire could create an unsafe condition and damage to the barbecue.
- ⚠ This appliance can be used by children aged from 8 years and above and persons with reduced physical, sensory or mental capabilities or lack of experience and knowledge if they have been given supervision or instruction concerning use of the appliance in a safe way and understand the hazards involved.
- ⚠ Children should be supervised to ensure that they do not play with the appliance. Cleaning and user maintenance shall not be made by children without supervision.

IP# IPX4

72024

EN - INTERNATIONAL ENGLISH
03/01/18

WARNINGS

⚠ DANGER

Failure to follow the **DANGERS, WARNINGS** and **CAUTIONS** contained in this Owner's Guide may result in serious bodily injury or death, or may result in a fire or an explosion causing damage to property.

- ⚠ Do not in any way alter this product or its use.
- ⚠ Use this barbecue only as described in this manual. Any other use not recommended in this manual may cause fire, electric shock, or injury to persons.
- ⚠ Do not use as a heater.
- ⚠ Do not leave barbecue unattended when in use.
- ⚠ Keep young children, elderly and pets away while barbecue is in use.
- ⚠ This appliance conforms to technical standards and the safety requirements for electrical devices.
- ⚠ Always ensure that electrical socket being used has the correct voltage according to the input power appliance. Sockets must also be suitable for equipment with a power consumption of 2200 Watts.
- ⚠ Make sure no other high wattage appliances are plugged into the same circuit when using barbecue.
- ⚠ Unplug barbecue when not in use.
- ⚠ Locate power cord away from traffic areas.
- ⚠ Do not allow cord to touch barbecue when it is hot.
- ⚠ Do not leave temperature controller in the ON position during short periods of non-use.
- ⚠ Pulling controller by the knob could cause it to come off. Remove temperature controller by gripping on its side.
- ⚠ This barbecue is intended for outdoor household use only. Do not use indoors or for commercial cooking.
- ⚠ Do not use barbecue near combustible materials such as wood, dry grass, shrubs, etc.
- ⚠ Do not allow barbecue to come into contact with flammable materials such as paper, walls, draperies, towels, chemicals, etc.
- ⚠ Do not use barbecue in high traffic areas.
- ⚠ Do not move the barbecue while it is in use. Allow the appliance to cool before moving or storing it.
- ⚠ To prevent barbecue from being splashed or falling into water, do not use barbecue within 305 cm (10 feet) of any body of water such as a pool or pond.
- ⚠ Do not build this model of barbecue in any built-in or slide-in construction. Ignoring this warning could cause a fire or an explosion that may damage property or cause serious bodily injury or death.
- ⚠ If a flare up occurs, do not use water to put out fire. Turn barbecue to OFF. Unplug power cord and wait for barbecue to cool.
- ⚠ Clean drip pan regularly.
- ⚠ The grease tray must be in place at all times during barbecue operation.
- ⚠ Do not use the temperature controller if outdoor temperatures falls below -25°C (-13°F) or exceeds 66°C (150°F).
- ⚠ Avoid damage from misuse such as immersing in water or any type of liquid, dropping, kicking, or stepping on any part of the temperature controller.
- ⚠ Do not use extension leads or plug adapters with this appliance. Doing so greatly reduces the effectiveness of the PRCD provided with your grill.
- ⚠ Use heat-resistant barbecue mitts or gloves (conforming to EN 407, Contact Heat rating level 2 or greater) when operating barbecue.

WARRANTY

Thank you for purchasing a WEBER product. Weber-Stephen Products LLC, 1415 S. Roselle Road, Palatine, Illinois 60067 ("WEBER") prides itself on delivering a safe, durable, and reliable product.

This is WEBER's Voluntary Warranty provided to you at no extra charge. It contains the information you will need to have your WEBER product repaired in the unlikely event of a failure or defect.

Pursuant to applicable laws, the customer has several rights in case the product is defective. Those rights include supplementary performance or replacement, abatement of the purchasing price, and compensation. In the European Union, for example, this would be a two-year statutory warranty starting on the date of the handover of the product. These and other statutory rights remain unaffected by this warranty provision. In fact, this warranty grants additional rights to the Owner that are independent from statutory warranty provisions.

WEBER'S VOLUNTARY WARRANTY

WEBER warrants, to the purchaser of the WEBER product (or in the case of a gift or promotional situation, the person for whom it was purchased as a gift or promotional item), that the WEBER product is free from defects in material and workmanship for the period(s) of time specified below when assembled and operated in accordance with the accompanying Owner's Manual. (Note: If you lose or misplace your WEBER Owner's Manual, a replacement is available online at www.weber.com, or such country-specific website to which Owner may be redirected.) Under normal, private single family home or apartment use and maintenance, WEBER agrees within the framework of this warranty to repair or replace defective parts within the applicable time periods, limitations, and exclusions listed below. TO THE EXTENT ALLOWABLE BY APPLICABLE LAW, THIS WARRANTY IS EXTENDED ONLY TO THE ORIGINAL PURCHASER AND IS NOT TRANSFERABLE TO SUBSEQUENT OWNERS, EXCEPT IN THE CASE OF GIFTS AND PROMOTIONAL ITEMS AS NOTED ABOVE.

OWNER'S RESPONSIBILITIES UNDER THIS WARRANTY

To ensure trouble-free warranty coverage, it is important (but it is not required) that you register your WEBER product online at www.weber.com, or such country-specific website to which Owner may be redirected. Please also retain your original sales receipt and/or invoice. Registering your WEBER product confirms your warranty coverage and provides a direct link between you and WEBER in case we need to contact you.

The above warranty only applies if the Owner takes reasonable care of the WEBER product by following all assembly instructions, usage instructions, and preventative maintenance as outlined in the accompanying Owner's Manual, unless the Owner can prove that the defect or failure is independent of non-compliance with the above mentioned obligations. If you live in a coastal area, or have your product located near a pool, maintenance includes regular washing and rinsing of the exterior surfaces as outlined in the accompanying Owner's Manual.

WARRANTY HANDLING / EXCLUSION OF WARRANTY

If you believe that you have a part which is covered by this Warranty, please contact WEBER Customer Service using the contact information on our website (www.weber.com), or such country-specific website to which Owner may be redirected). WEBER will, upon investigation, repair or replace (at its option) a defective part that is covered by this Warranty. In the event that repair or replacement are not possible, WEBER may choose (at its option) to replace the grill in question with a new grill of equal or greater value. WEBER may ask you to return parts for inspection, shipping charges to be pre-paid.

This WARRANTY lapses if there are damages, deteriorations, discolorations, and/or rust for which WEBER is not responsible caused by:

- Abuse, misuse, alteration, modification, misapplication, vandalism, neglect, improper assembly or installation, and failure to properly perform normal and routine maintenance;
- Insects (such as spiders) and rodents (such as squirrels), including but not limited to damage to burner tubes and/or gas hoses;
- Exposure to salt air and/or chlorine sources such as swimming pools and hot tubs/spas;
- Severe weather conditions such as hail, hurricanes, earthquakes, tsunamis or surges, tornadoes or severe storms.

The use and/or installation of parts on your WEBER product that are not genuine WEBER parts will void this Warranty, and any damages that result hereby are not covered by this Warranty. Any conversion of a gas grill not authorised by WEBER and performed by a WEBER authorised service technician will void this Warranty.

PRODUCT WARRANTY PERIODS

Cookbox:
5 years, no rust through/burn through
(2 years paint excluding fading or discolouration)

Lid assembly:
5 years, no rust through/burn through
(2 years paint excluding fading or discolouration)

Porcelain-enamelled cast iron cooking grates:
5 years, no rust through/burn through

Plastic components:
5 years, excluding fading or discolouration

All remaining parts:
2 years

DISCLAIMERS

APART FROM THE WARRANTY AND DISCLAIMERS AS DESCRIBED IN THIS WARRANTY STATEMENT, THERE ARE EXPLICITLY NO FURTHER WARRANTY OR VOLUNTARY DECLARATIONS OF LIABILITY GIVEN HERE WHICH GO BEYOND THE STATUTORY LIABILITY APPLYING TO WEBER. THE PRESENT WARRANTY STATEMENT ALSO DOES NOT LIMIT OR EXCLUDE SITUATIONS OR CLAIMS WHERE WEBER HAS MANDATORY LIABILITY AS PRESCRIBED BY STATUTE.

NO WARRANTIES SHALL APPLY AFTER THE APPLICABLE PERIODS OF THIS WARRANTY. NO OTHER WARRANTIES GIVEN BY ANY PERSON, INCLUDING A DEALER OR RETAILER, WITH RESPECT TO ANY PRODUCT (SUCH AS ANY "EXTENDED WARRANTIES"), SHALL BIND WEBER. THE EXCLUSIVE REMEDY OF THIS WARRANTY IS REPAIR OR REPLACEMENT OF THE PART OR PRODUCT.

IN NO EVENT UNDER THIS VOLUNTARY WARRANTY SHALL RECOVERY OF ANY KIND BE GREATER THAN THE AMOUNT OF THE PURCHASE PRICE OF THE WEBER PRODUCT SOLD.

YOU ASSUME THE RISK AND LIABILITY FOR LOSS, DAMAGE, OR INJURY TO YOU AND YOUR PROPERTY AND/OR TO OTHERS AND THEIR PROPERTY ARISING OUT OF THE MISUSE OR ABUSE OF THE PRODUCT OR FAILURE TO FOLLOW INSTRUCTIONS PROVIDED BY WEBER IN THE ACCOMPANYING OWNER'S MANUAL.

PARTS AND ACCESSORIES REPLACED UNDER THIS WARRANTY ARE WARRANTED ONLY FOR THE BALANCE OF THE ABOVE MENTIONED ORIGINAL WARRANTY PERIOD(S).

THIS WARRANTY APPLIES TO PRIVATE SINGLE FAMILY HOME OR APARTMENT USE ONLY AND DOES NOT APPLY TO WEBER GRILLS USED IN COMMERCIAL, COMMUNAL OR MULTI-UNIT SETTINGS SUCH AS RESTAURANTS, HOTELS, RESORTS, OR RENTAL PROPERTIES.

WEBER MAY FROM TIME TO TIME CHANGE THE DESIGN OF ITS PRODUCTS. NOTHING CONTAINED IN THIS WARRANTY SHALL BE CONSTRUED AS OBLIGATING WEBER TO INCORPORATE SUCH DESIGN CHANGES INTO PREVIOUSLY MANUFACTURED PRODUCTS, NOR SHALL SUCH CHANGES BE CONSTRUED AS AN ADMISSION THAT PREVIOUS DESIGNS WERE DEFECTIVE.

Refer to International Business Units list at the end of this Owner's Manual for additional contact information.

TABLE OF CONTENTS

| | |
|---|----|
| WARNINGS | 2 |
| WARRANTY | 3 |
| TABLE OF CONTENTS | 3 |
| EXPLODED VIEW - Q 1400 | 4 |
| EXPLODED VIEW - Q 2400 | 5 |
| PARTS LIST | 6 |
| ASSEMBLY | 7 |
| GENERAL INSTRUCTIONS | 8 |
| REGISTER YOUR GRILL | 8 |
| STORAGE AND/OR NONUSE | 8 |
| OPERATING | 8 |
| BEFORE USING THE GRILL | 8 |
| CATCH PAN AND DISPOSABLE DRIP PAN | 8 |
| COOKING ON YOUR ELECTRIC GRILL | 9 |
| TROUBLESHOOTING | 10 |
| MAINTENANCE | 11 |
| CLEANING | 11 |
| CLEANING REMOVABLE BOWL LINER | 11 |

The grills illustrated in this Owner's Guide may vary slightly from the model purchased.

EXPLODED VIEW - Q 1400

Q 1400_ELECTRIC_EURO_061015

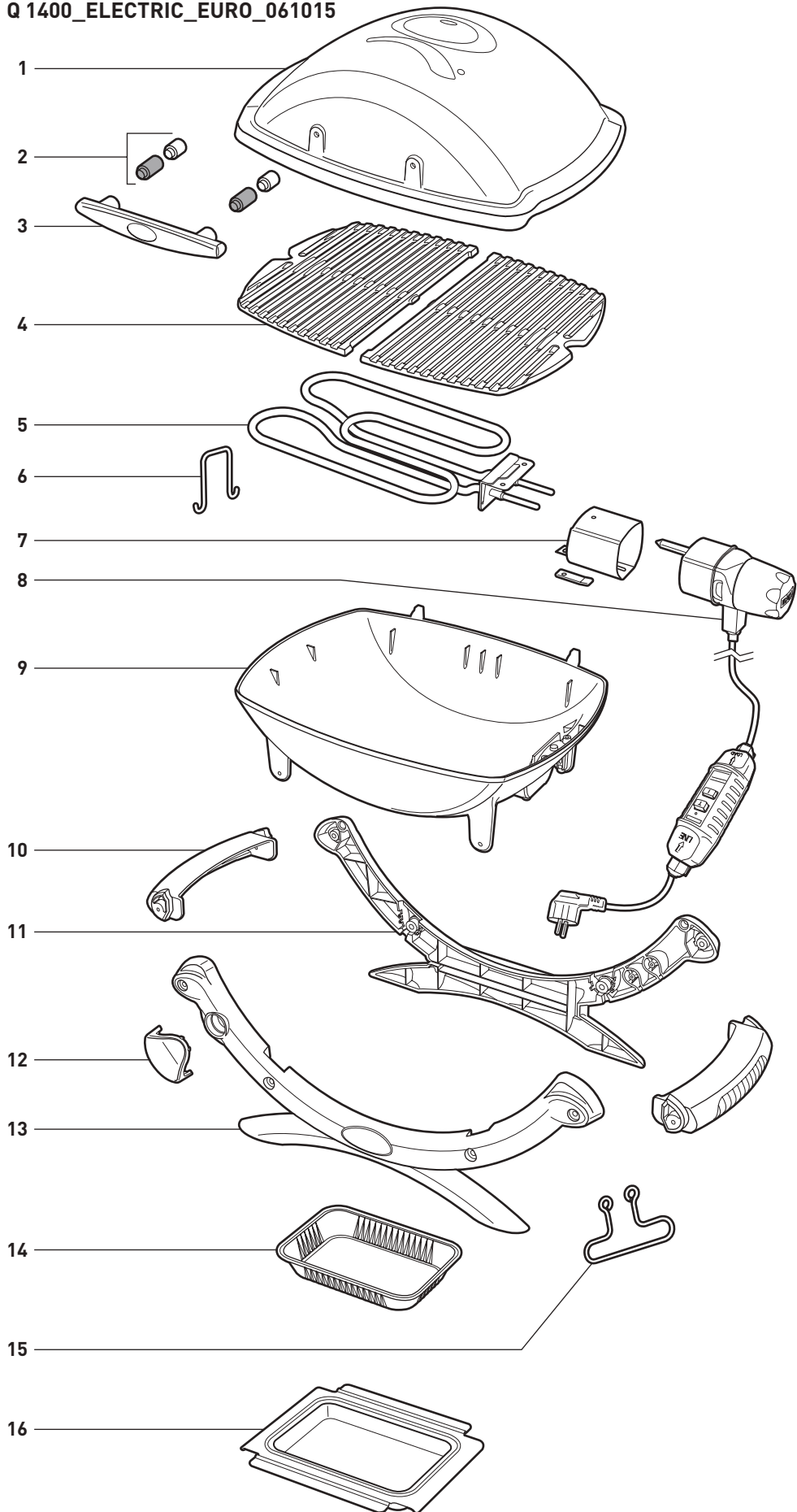

1. Lid
2. Ceramic Spacer/Plastic Spacer
3. Handle
4. Cooking Grate
5. Heat Element Assembly
6. Heat Element Support
7. Controller Bracket Sleeve
8. Temperature Controller
9. Cookbox
10. Carrying Handle
11. Rear Cradle
12. Cradle Logo
13. Front Cradle
14. Disposable Drip Pan
15. Wire Hanger
16. Catch Pan

EXPLODED VIEW - Q 2400

Q 2400_ELECTRIC_EURO_061015

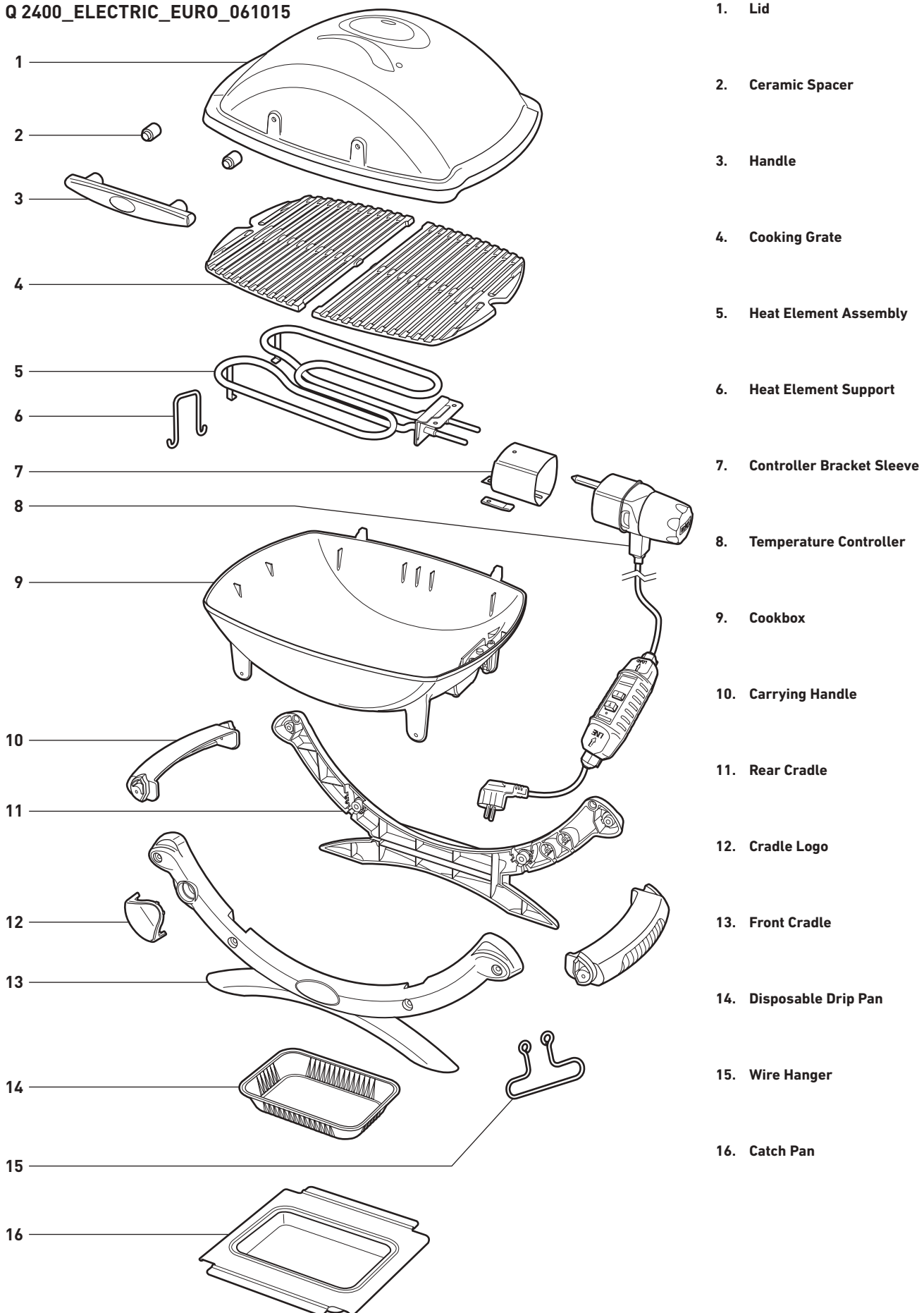

1. Lid
2. Ceramic Spacer
3. Handle
4. Cooking Grate
5. Heat Element Assembly
6. Heat Element Support
7. Controller Bracket Sleeve
8. Temperature Controller
9. Cookbox
10. Carrying Handle
11. Rear Cradle
12. Cradle Logo
13. Front Cradle
14. Disposable Drip Pan
15. Wire Hanger
16. Catch Pan

PARTS LIST

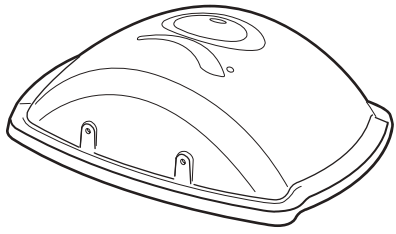

..... 1

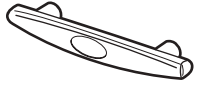

..... 1

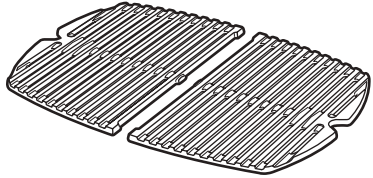

..... 1

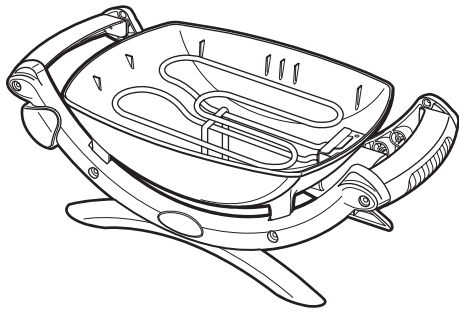

..... 1

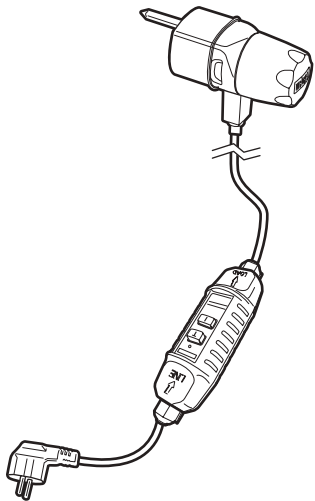

..... 1

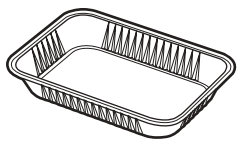

..... 1

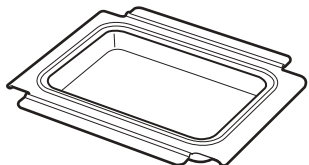

..... 1

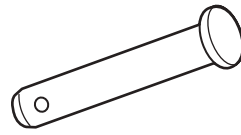

2



2

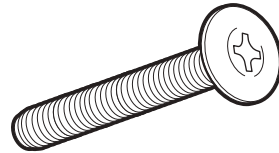

2

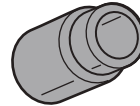

2

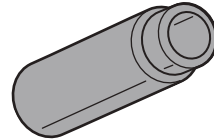

2

ASSEMBLY

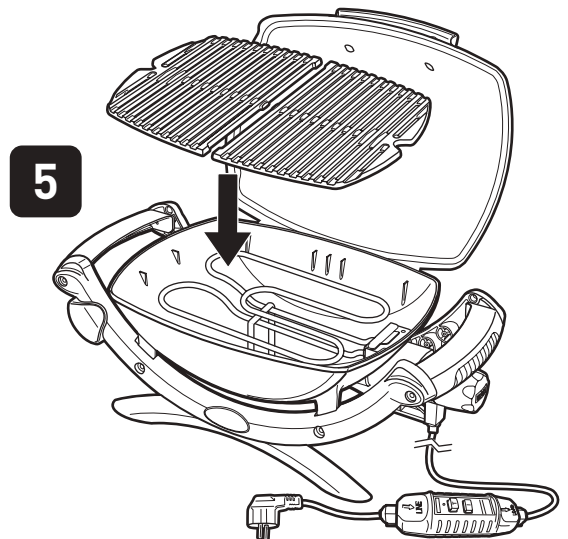
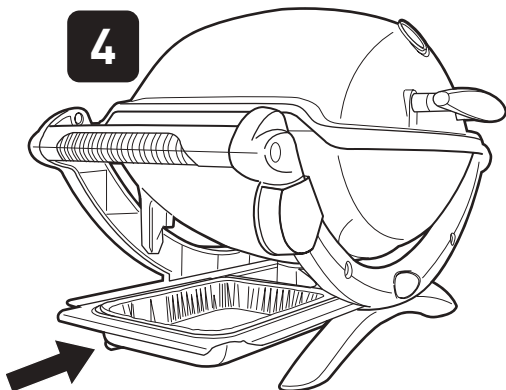
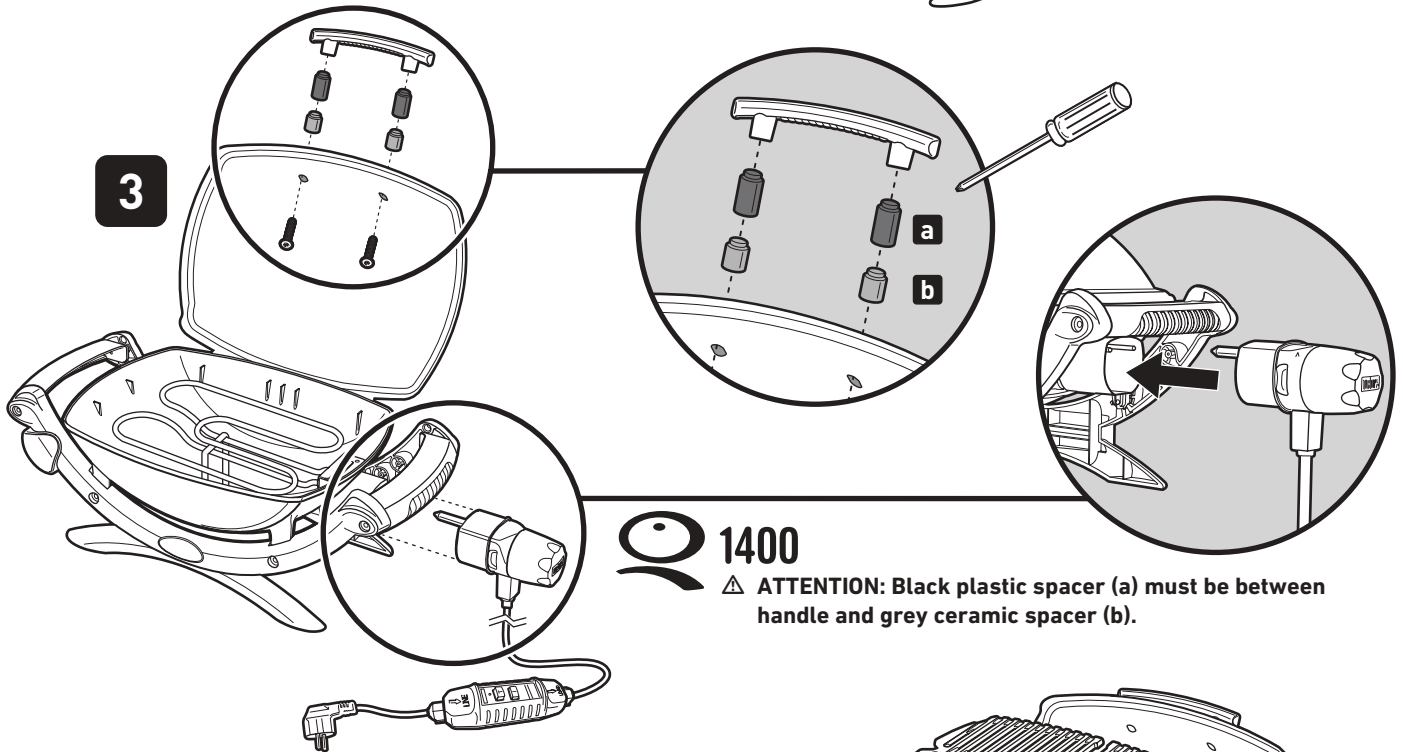
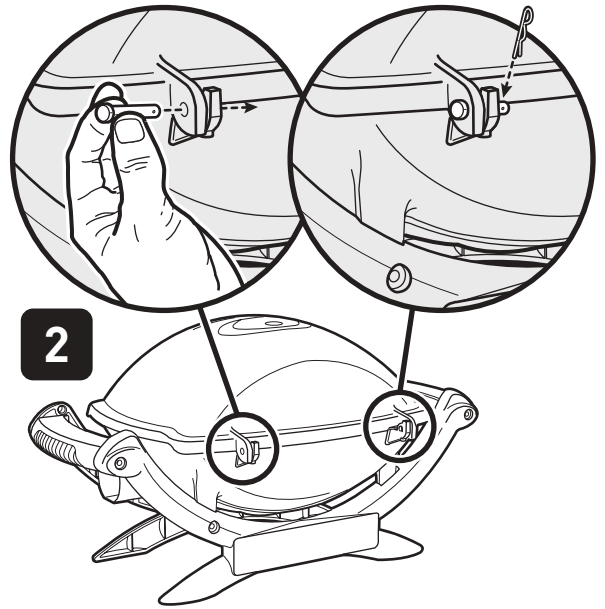
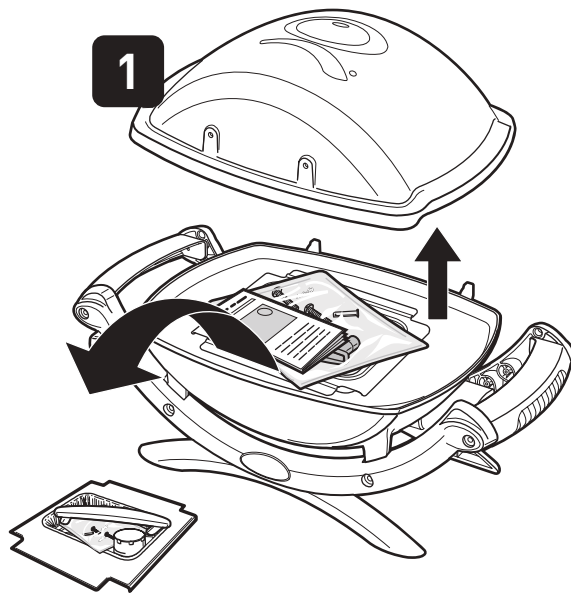

GENERAL INSTRUCTIONS

If you have questions or need advice regarding your grill or its safe operation contact the Customer Service Representative in your area. Use the contact information on our web site. Log onto www.weber.com.

With the WEBER electric barbecue you can grill, barbecue, roast and bake with results that are difficult to duplicate with indoor kitchen appliances. The closed lid produces that "outdoor" flavour in the food. Electricity is easy to use and gives you more cooking control than charcoal fuel.

- These instructions will give you the minimum requirements for assembling your WEBER electric barbecue. Please read the instructions carefully before using your WEBER electric barbecue. Improper assembly can be dangerous.
- This WEBER electric barbecue is not intended for commercial use.
- Do not leave the WEBER electric barbecue unattended when it is in use.
- Any parts sealed by the manufacturer must not be altered by the user.
- Any modification of the appliance may be dangerous.
- Visually inspect cord, plug and heating element controller for damage and wear before operation.
- When heating the grill for the first time, it may give off a slight burning odor. The grill is burning off excess lubricants found on the heating element. This does not affect the safety of your grill.
- To prevent fire or electric shock, always use a certified electrician should new circuits or outlets be required.
- Improperly grounded outlets could cause electrical shock.
- Keep connections off the ground and dry. Do not let cord hang over edge of table top where it can be tripped over or pulled by children.
- Cover grill or store in weather protected area when not in use.
- Clean the grate and cookbox between uses.

STORAGE AND/OR NON-USE

- When the WEBER electric barbecue is not in use, the temperature control knob with power cord should be in the "OFF" position and must be DISCONNECTED and stored indoors.

OPERATING

- ⚠ **WARNING: Your WEBER electric barbecue must not be used under any combustible surface.**
- ⚠ **WARNING: Your WEBER electric barbecue is not intended for installation in or on recreational vehicles and caravans and/or boats.**
- ⚠ **WARNING: Do not use the barbecue within 60 cm (24 in) of combustible materials, of back or sides of the grill.**
- ⚠ **WARNING: The entire cooking box gets hot when in use. Do not leave unattended.**
- ⚠ **WARNING: Keep any electrical power cord away from any heated surface.**
- ⚠ **WARNING: Keep the cooking area clear of inflammable vapours and liquids such as petrol, kerosene, alcohol, etc., and other combustible materials.**
- ⚠ **WARNING: When cooking, the appliance must be on a level, stable surface in an area clear of combustible material.**
- ⚠ **WARNING: Completely unwind power cord before use. Keep cord clear of cookbox.**
- ⚠ **Use heat-resistant barbecue mitts or gloves (conforming to EN 407, Contact Heat rating level 2 or greater) when operating barbecue.**

BEFORE USING THE GRILL

CATCH PAN AND DISPOSABLE DRIP PAN

Your grill was built with a grease collection system. Check the catch pan and disposable drip pan for grease build-up each time you use your grill.

Remove excess grease with a plastic spatula; see illustration. When necessary, wash the catch pan and drip pan with a soap and water solution, then rinse with clean water. Replace the disposable drip pan as needed.

- ⚠ **WARNING: Check the catch pan and disposable drip pan for grease build-up before each use. Remove excess grease to avoid a grease fire. A grease fire can cause serious bodily injury or damage to property.**

- ⚠ **CAUTION: Do not line the slide-out grease tray with aluminum foil.**

(Q 2400) - Make sure that disposable drip pan (a) rests flat on catch pan (b). A bent drip pan may interfere with removal of catch pan.

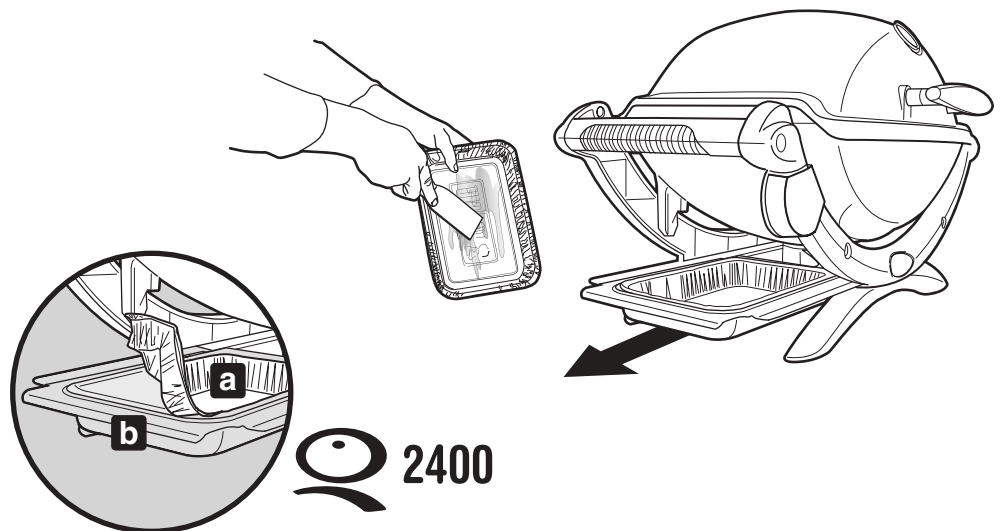

COOKING ON YOUR ELECTRIC GRILL

**This appliance is rated for
220V-240V - 50/60Hz
Output: 2200 W**

⚠ WARNING: Completely unwind power cord. Keep cord clear of cookbox.

1) Plug temperature controller into grill.

⚠ Always plug Temperature Controller fully into grill before plugging power cord into outlet.

2) Open Lid.
3) Make sure the control knob is turned OFF. (Turn control knob counterclockwise to ensure that it is in the OFF position.)

4) Plug in power cord into a protected outlet.

⚠ CAUTION: The appliance should be supplied through a residual current device (RCD).

5) **Before grilling, check that the electronic safety device on the temperature controller power cord is working properly.**

- Press the "reset" button on the cord (I). The indicator light should turn on. Then, press the "test" button (T). The indicator light should then turn off.

⚠ WARNING: If the test function fails DO NOT OPERATE THE GRILL. Contact the Customer Service Representative in your area using the contact information on our web site. Log onto www.weber.com.

6) Press the "reset" button on the cord (I).

7) Preheat the grill. Turn control knob to HIGH (clockwise). The red light indicates that power is on and the heating element is heating up. The red light periodically turns on and off as the heating element adjusts to maintain temperature.

8) Close lid. Preheat time will take approximately 20 minutes.

To cook at a lower grill temperature: Preheat as outlined above. Turn the control knob counterclockwise to desired setting. Start cooking.

Reference the cooking charts at end of Owner's Guide for approximate grilling times and settings for the cuts of meats listed (adjust for conditions).

⚠ WARNING: When red light is off, heating element may still be hot.

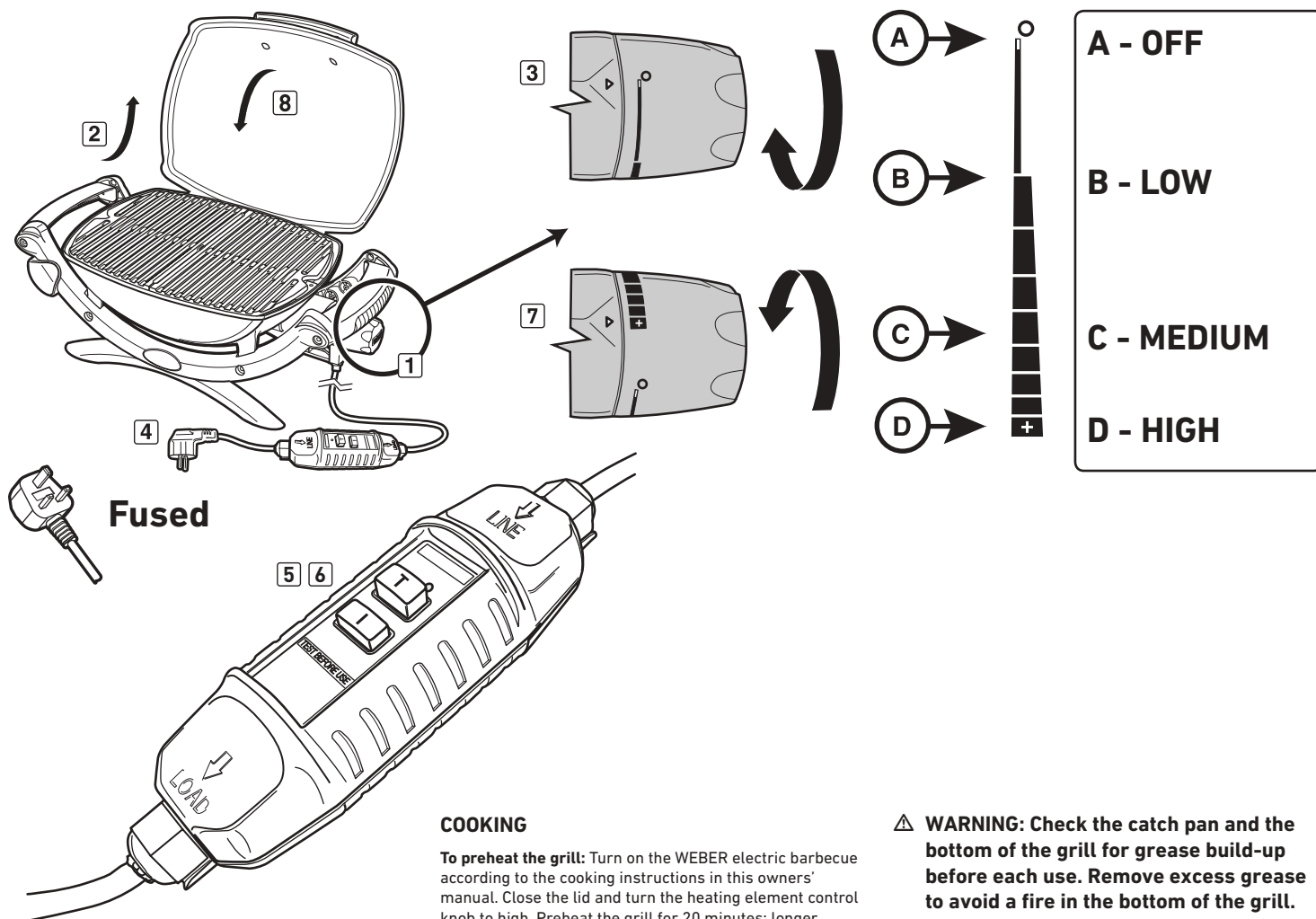

COOKING

To preheat the grill: Turn on the WEBER electric barbecue according to the cooking instructions in this owners' manual. Close the lid and turn the heating element control knob to high. Preheat the grill for 20 minutes; longer preheating time will depend on conditions such as air temperature and wind. Allow five more minutes of preheat time in countries where voltage is 220 volts.

Note: Wind and weather may require adjustment of the Temperature Control Knob to obtain the correct cooking temperature.

Drippings and grease: Excess drippings and grease will collect in the catch pan in the slide-out bottom tray (located on the underside of the grill). Disposable WEBER drip pans are available that fit the catch pan.

⚠ WARNING: Check the catch pan and the bottom of the grill for grease build-up before each use. Remove excess grease to avoid a fire in the bottom of the grill.

⚠ WARNING: Do not move the WEBER electric grill when operating or while the grill is hot.

COOKING ON YOUR ELECTRIC GRILL

You must preheat the grill (**20 minutes**) before you cook on it.

A light coating of oil will help brown your food evenly and keep it from sticking to the cooking grate. Always brush or spray oil onto your food, not directly onto the cooking grate.

We suggest that you grill with the lid down. Why? Because it reduces the chance of flare-ups, and cooks your food faster and more evenly.

When using a marinade, sauce or glaze with a high sugar content or other ingredients that burn easily, only brush it onto the food during the last 10 to 15 minutes of grilling.

Don't forget to regularly brush off your cooking grate and clean out the drip pan under the grill.

The following cuts, thicknesses, weights, and grilling times for food are meant to be guidelines rather than hard and fast rules. Cooking times are affected by such factors as wind, outside temperature and how well done the food should be cooked. Grill for the time given on the chart or to the desired degree of doneness, turning once halfway through the grilling time. Cooking times for beef and lamb are for "medium" cooking time, unless otherwise noted. Let thick chops and steaks rest for 5 to 10 minutes before carving. The internal temperature of the meat will rise by 5 to 10 degrees during this time.

For more grilling tips and recipes, visit www.weber.com.

| | CUT | THICKNESS AND/OR WEIGHT | APPROXIMATE GRILLING TIME |
|-----------------------|-------------------------------------|--|--|
| Beef | Steak: fillet, rump or entrecote | 2 cm (3/4 in) thick | 10 to 14 minutes, High |
| | | 2.5 cm (1 in) thick | 14 to 16 minutes, High |
| | | 2.5 – 3 cm (1 to 1-1/2 in) thick | 18 to 20 minutes; High |
| | Kebab | 2.5 – 3 cm (1 to 1-1/2 in) cubes | 12 to 14 minutes, High |
| Beefburger or rissole | 2 cm (3/4 in) thick | 12 to 16 minutes, High | |
| Lamb | Lamb Chops | 3cm (1-1/2 in) thick | 20 minutes, High |
| | Boneless Leg of Lamb | 1.4 - 1.6 kg (3 to 3-1/2 lb) | 1 Hr. 30 to 1 Hr. 40 minutes, Medium |
| | Rack of Lamb | | 35 to 40 minutes, Medium |
| Pork | Chop: rib, loin, or shoulder | 2–2.5 cm (3/4 to 1 inch) thick | 20 to 30 minutes, Medium |
| | Loin, boneless | 2–2.5 cm (3/4 to 1 in) thick | 16 to 18 minutes, Medium |
| | Sausage | | 28 to 32 minutes, Medium |
| Poultry | Chicken breast, boneless, skinless | 175 g (6 oz) | 12 to 14 minutes, Medium |
| | Kebab | 2.5 – 3 cm (1 to 1-1/2 in) cubes | 14 to 16 minutes, High |
| | Chicken, half | 550 – 675g (1-1/4 to 1-1/2 lb) | 1 to 1-1/4 hours, Medium |
| | Chicken pieces, bone-in breast/wing | | 40 minutes, Medium |
| | Chicken pieces, bone-in leg/ thigh | | 40 to 50 minutes, Medium |
| Fish & Seafood | Fish, fillet or slice | 1 – 2.5 cm (1/2 to 1 in) thick 2.5- 3cm (1 to 1-1/4 in) thick | 8 to 10 minutes, High 10 to 12 minutes, High |
| | Prawns | | 2 to 5 minutes, High |
| | Whole Fish | 450g (1 lb) 1 kg (2 to 2 1/2 lb) | 15 to 20 minutes, Medium 20 to 30 minutes, Medium |
| Vegetables | Asparagus | | 8 to 10 minutes, High |
| | Corn on the cob, husked | | 12 to 14 minutes, High |
| | Corn on the cob, in husk | | 25 to 30 minutes, High |
| | Mushroom: Portabello | | 12 to 15 minutes, High |
| | Mushroom: Button | | 10 to 12 minutes, High |
| | Onion, .64 cm (1/4 in) slices | | 10 to 12 minutes, High |
| | Potato, .64 cm (1/4 in) slices | | 10 to 12 minutes, High |
| | Aubergine, 1.27cm (1/2 in) slices | | 10 to 12 minutes, High |
| | Peppers (Whole) | | 12 to 15 minutes, High |
| | Peppers (Quartered) | | 8 to 10 minutes, High |
| | Zucchini 1.27cm (1/2 in) | | 8 to 10 minutes, High |
| | Zucchini (Halved) | | 12 to 14 minutes, High |

TROUBLESHOOTING

| PROBLEM | CHECK | CURE |
|--|---|--|
| Electric grill does not turn on. | Is the temperature controller properly inserted into housing? | Remove and reinstall temperature controller. |
| | Is red power light on and temperature control knob fully turned clockwise to HIGH? | ⚠ Always plug Temperature Controller fully into grill before plugging power cord into outlet. |
| | Is power flowing from outlet? | Check electrical power supply. |
| | Make sure that the electronic safety indicator light is lit on the temperature controller cord. | Press the "reset" button on the temperature controller cord. The indicator light should turn on. |
| If problems cannot be corrected by using these methods, please contact the Customer Service Representative in your region using the contact information on our web site. Log onto www.weber.com . | | |

CLEANING

- ⚠ **WARNING:** turn your WEBER electric barbecue OFF and wait for it to cool before cleaning.

Temperature controller with power cord - Use a warm soapy water solution and a damp rag. Wipe and completely dry off before using.

- ⚠ **WARNING:** To protect against electrical shock, do not immerse plug, cord, heating element, or temperature controller in water or any other liquid.

Outside surfaces - Use a warm soapy water solution to clean, then rinse with water.

- ⚠ **CAUTION:** Do not use oven cleaner, abrasive cleansers (kitchen cleansers), cleaners that contain citrus products, or abrasive cleaning pads on the barbecue.

- ⚠ **CAUTION:** Do not clean grill with metal scrubbing pads. Pieces can break off from the pad and short electrical parts.

- ⚠ **Clean drip pan regularly.**

Cooking grate - A general cleaning of the cooking grate can be done immediately following cooking. While grill is still warm brush grate with a steel bristle brush.

- ⚠ **CAUTION:** Grill brushes should be checked for loose bristles and excessive wear on a regular basis. Replace brush if any loose bristles are found on cooking grates or brush. WEBER recommends purchasing a new stainless steel grill brush at the beginning of every spring.

To thoroughly clean when grill is cool, use a steel bristle brush to remove particles, as needed. Remove the cool cooking grate from grill and wash with warm soapy water, then rinse with water.

For availability of replacement cooking grate, contact the Customer Service Representative in your area, using the contact information on our web site. Log onto www.weber.com.

Catch pan - Check the catch pan for grease build-up each time you use your grill. Remove excess grease with a plastic scraper. Wash the catch pan with warm, soapy water and rinse with water. Disposable WEBER drip pans are available that fit the catch pan.

- ⚠ **Clean Catch pan regularly.**

Inside Lid - While lid is warm, wipe inside with paper towels to prevent grease build-up. Flaking, built-up grease resembles paint flakes.

Do not use cleaners that contain acid, mineral spirit or xylene. Rinse well after cleaning.

CLEANING INSIDE COOKBOX

- ⚠ **WARNING:** turn your WEBER electric barbecue OFF and wait for it to cool before cleaning.

- ⚠ **WARNING:** Avoid grease build up on the grate and inside the cookbox. Regular cleaning of the grate and cookbox between uses is necessary to avoid grease build up. Improper maintenance can lead to a grease fire which could cause serious bodily injury or death, and damage to property.

1) Unplug temperature controller power cord. Grasp controller by base behind the control knob (a) and pull to remove (b).

- ⚠ **CAUTION:** Pulling controller by the knob could cause it to come off.

2) Scrape the inside cookbox with a plastic scraper to remove excess grease build up.

- ⚠ **CAUTION:** the heat element support is required for safety by the regulatory agency and should not be removed.

- ⚠ **CAUTION:** Do not use oven cleaner, abrasive cleansers (kitchen cleansers), cleaners that contain citrus products, or abrasive cleaning pads on the heating element. Do not use cleaners that contain acid, mineral spirits or xylene.

3) Replace temperature control knob & power cord before use.

- ⚠ **Always plug temperature controller fully into grill before plugging power cord into outlet.**

Excess drippings and grease will accumulate in the catch pan under the slide-out bottom tray. Disposable foil drip pans are available that fit the catch pan.

- ⚠ **WARNING:** Check the bottom tray for grease build-up before each use. Remove excess grease to avoid a grease fire in the slide-out bottom tray.

- ⚠ **Should a grease fire occur, turn off temperature controller and leave lid closed until fire is out.**

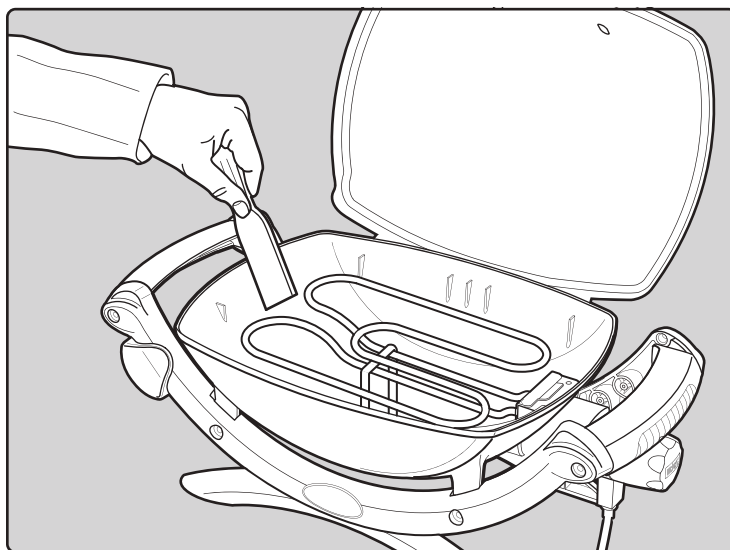
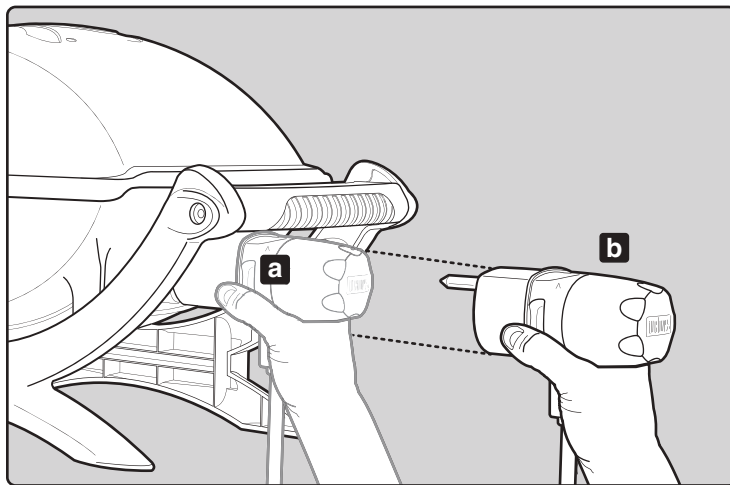

⚠ ATTENTION: This product has been safety tested and is only certified for use in a specific country. Refer to country designation located on outer carton.

Please contact Weber-Stephen Products LLC Customer Service Department for genuine Weber-Stephen Products LLC replacement part(s) information.

⚠ WARNING: Do not attempt to make any repair to components without contacting Weber-Stephen Products LLC Customer Service Department. Your actions, if you fail to follow this product Warning, may cause a fire or an explosion resulting in serious personal injury or death and damage to property.



This symbol indicates that the product cannot be disposed of in the trash. For instructions regarding proper disposal of this product in Europe, please visit www.weber.com, and contact the importer listed for your country. If you do not have internet access, contact your dealer for the importer's name, address and telephone number.

AUSTRALIA

Weber-Stephen Products LLC
R. McDonald Co. PTY. LTD.
+61.8.8221.6111

AUSTRIA

Weber-Stephen Österreich GmbH
+43 7242 890 135 0
info-at@weberstephen.com

BELGIUM

Weber-Stephen Products Belgium Sprl
+32 015 28 30 90
infobelux@weberstephen.com

CHILE

Weber-Stephen Chile SpA.
+01 56 2-3224-3936

CZECH REPUBLIC

Weber-Stephen CZ & SK spol. s r.o.
+42 267 312 973
info-cz@weberstephen.com

DENMARK

Weber-Stephen Nordic ApS
+45 99 36 30 10
info@weberstephen.dk

FRANCE

Weber-Stephen France
+33 810 19 32 37
service.consommateurs@weberstephen.com

GERMANY

Weber-Stephen Deutschland GmbH
+49 6132 8999 0
info-de@weberstephen.com

HUNGARY

Weber-Stephen Magyarország Kft.
+36 70 / 70-89-813
info-hu@weberstephen.com

ICELAND

Jarn & Gler Wholesale EHF
+354 58 58 900

INDIA

Weber-Stephen Barbecue Products India Pvt. Ltd.
080 42406666
customercare@weberindia.com

ISRAEL

D&S Imports
+972 392 41119
info@weber.co.il

ITALY

Weber-Stephen Products Italia Srl
+39 0444 360 590
info-italia@weberstephen.com

MEXICO

Weber-Stephen Products S.A. de C.V.
+01800-00-WEBER [93237] Ext. 105

NETHERLANDS

Weber-Stephen Netherlands B.V.
+31 513 4333 22
info@weberbarbecues.nl

NEW ZEALAND

WEBER New Zealand ULC
+64 9 570 6630

POLAND

Weber-Stephen Polska Sp. z o.o.
+48 22 392 04 69
info-pl@weberstephen.com

RUSSIA

Weber-Stephen Vostok LTD.
+7 495 956 63 21
info.ru@weberstephen.com

SOUTH AFRICA

Weber-Stephen Products (South Africa) (Pty) Ltd.
+27 11 454 2369
info@weber.co.za

SPAIN

Weber-Stephen Iberica Srl
+34 93 584 40 55
infoiberica@weberstephen.com

SWITZERLAND

Weber-Stephen Schweiz GmbH
+41 52 24402 50
info-ch@weberstephen.com

TURKEY

WEBER Stephen Turkey
Ev ve Bahçe Malzemeleri Ticaret Ltd. Şti
+90 212 659 64 80

UNITED ARAB EMIRATES

Weber-Stephen Nordic Middle East
+971 4 360 9256
info@weberstephen.ae

UNITED KINGDOM

Weber-Stephen Products (UK) Ltd.
+44 (0)203 630 1500
customerserviceuk@weberstephen.com

USA

Weber-Stephen Products LLC
847 934 5700
support@weberstephen.com

For Republic of Ireland, please contact:
Weber-Stephen Products (U.K.) Limited.

For other eastern European countries, such as ROMANIA,
SLOVENIA, CROATIA, or GREECE, please contact:
Weber-Stephen Deutschland GmbH.

For Baltic states, please contact:
Weber-Stephen Nordic ApS.

weber.com



WEBER-STEPHEN PRODUCTS LLC
www.weber.com

© 2018 Designed and engineered by Weber-Stephen Products LLC,
1415 S. Roselle Road, Palatine, Illinois 60067 USA.

The WEBER Q grill includes designs and features originally created by Robert DeMars of Original Ideas, Inc.